

3.3kVA Single Phase Portable Tool Transformer 110V with 2 x 16A Sockets

Product Ref: **CM33002/CL**

Technical Features:

- 1650VA Continuous rating
- 3300VA Tool rating
- Supplied with 2 x 16A 2P+E Sockets
- Supplied with 2m Rubber Power cable & 3 Pin BS Plug
- Robust GRP enclosure with carry handle

Product Specification

Continuous Rating	1650VA
Tool Rating	3300VA
Intermittent Duty	3300VA - 5 Min ON / 15 Min OFF
Input Voltage	230/240V AC
Power Cable Length	1.7m
Power Cable Type	H07RN-F 3G 1.5mm ²
Power Cable Plug	3 Pin BS Plug
Output Voltage	110V AC
Frequency	50/60Hz
Output Sockets (Total)	2
Output Socket Type	IP44 16A CEE Socket x 2
Output Socket Rating (Amps)	16A
Safety Thermal Cut Out	Yes
Class	Class I
IP Rating	IP44
Enclosure Material	Glass Reinforced Plastic (GRP)
Colour	Yellow
Compliance	UKCA, CE
Standards	BS EN IEC 61558-1/2-23
Guarantee	1 Year
Weight	16.500kg
Depth	235mm
Height	262mm
Width	192mm

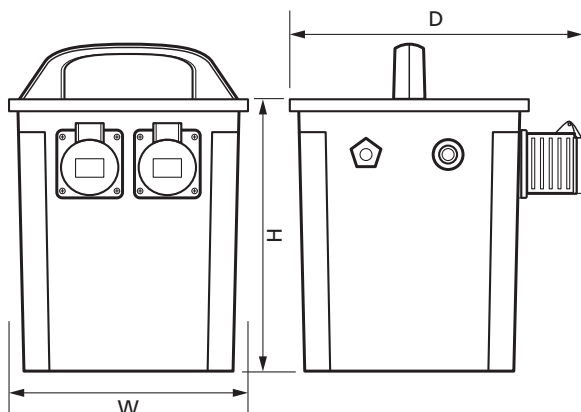

Errors and omissions excepted (E&OE). All information is subject to change without notice and is correct at the time of print. Refer to issue number and date below.

Tel: +44 (0)1302 342 642 • mcg.co.uk • [@mcg_industrial](https://twitter.com/mcg_industrial)